



CE-5 MATCH

Linha Canal Equipado Match

Calha úmida em aço inox 304 com rebaixo para encaixe de 5 a 10 acessórios.

Acabamento escovado hairline finishing.

Instalação: Embutir ou sobrepor.

Abertura para válvula: 3½" (válvula já inclusa)

Características Dimensionais - Calha

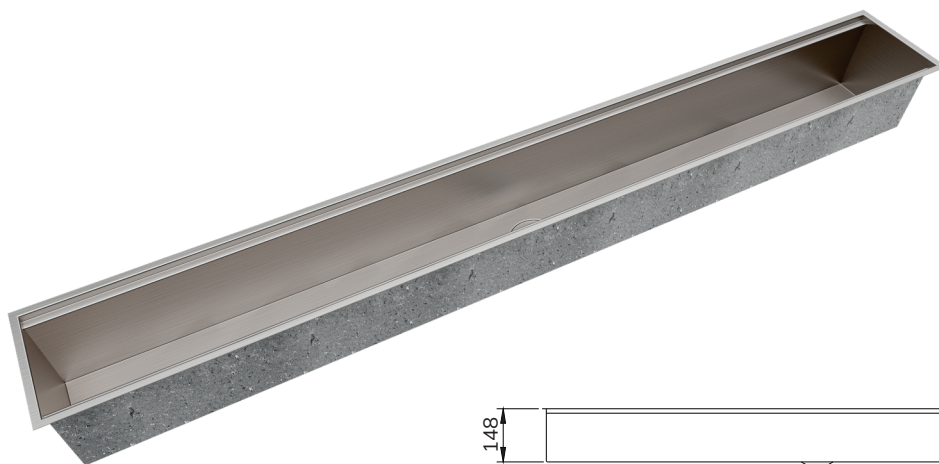

Cód. 01720716

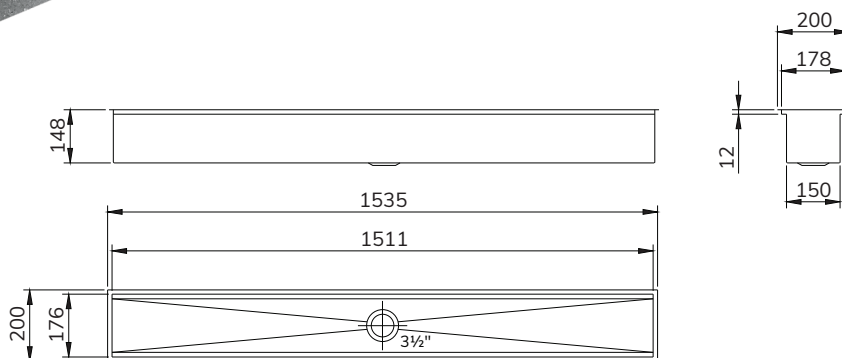

Características Dimensionais - Acessórios (vendidos separadamente)



Porta Pratos Match
01721316

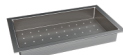
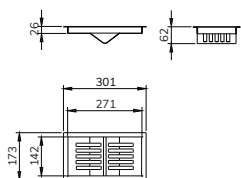

Escorredor de Talheres e Copos Match
01034916

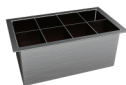
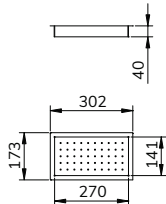

Porta Utensílios Match
01037816

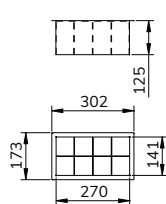

Mini Porta Utensílios Match
01721216

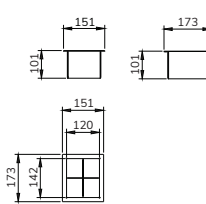

Container com Tampa Match
01034816

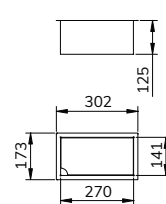

Mini Container com Tampa Match
01721116

