



CE-2 MATCH

## Linha Canal Equipado Match

Calha úmida em aço inox 304 com rebaixo para encaixe de 2 a 4 acessórios.

Acabamento escovado hairline finishing.

**Instalação:** Embutir ou sobrepor.

**Abertura para válvula:** 3½" (válvula já inclusa)

### Características Dimensionais - Calha

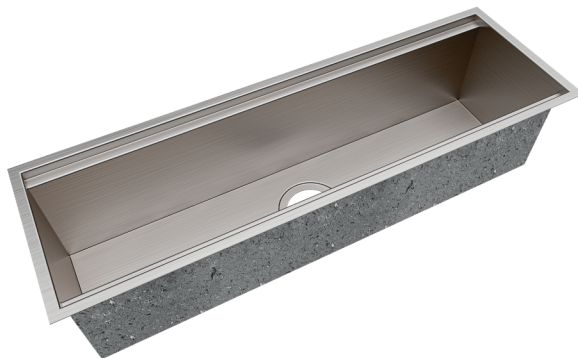

Cód. 01720516

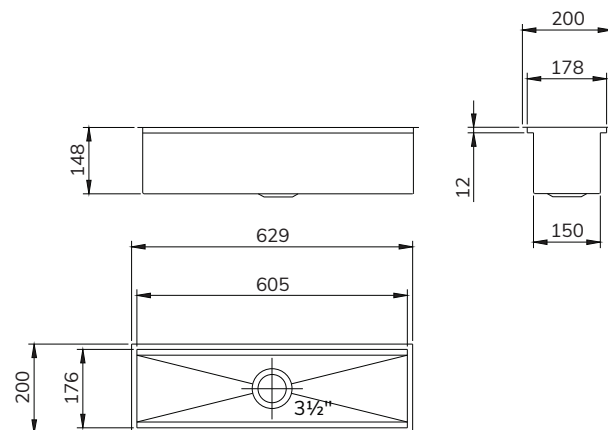

### Características Dimensionais - Acessórios (vendidos separadamente)



Porta Pratos Match  
01721316

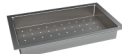
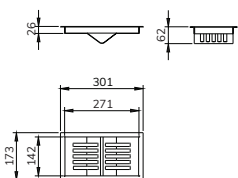

Escorredor de Talheres e Copos Match  
01034916

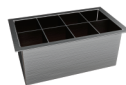
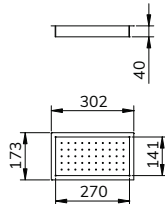

Porta Utensílios Match  
01037816

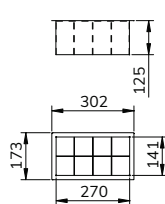

Mini Porta Utensílios Match  
01721216

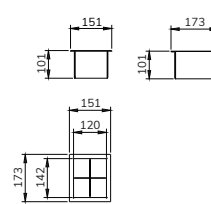

Container com Tampa Match  
01034816

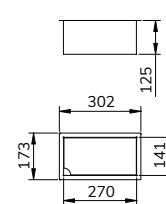

Mini Container com Tampa Match  
01721116

